

SKF bushings, thrust washers and strips

A wide assortment for virtually every application





The SKF brand now stands for more than ever before, and means more to you as a valued customer.

While SKF maintains its leadership as the hallmark of quality bearings throughout the world, new dimensions in technical advances, product support and services have evolved SKF into a truly solutions-oriented supplier, creating greater value for customers.

These solutions encompass ways to bring greater productivity to customers, not only with breakthrough application-specific products, but also through leading-edge design simulation tools and consultancy services, plant asset efficiency maintenance programmes, and the industry's most advanced supply management techniques.

The SKF brand still stands for the very best in rolling bearings, but it now stands for much more.

SKF – the knowledge engineering company

Contents

1 Product information

A wide assortment to meet your needs	3
SKF solid bronze bushings	4
SKF sintered bronze bushings	6
SKF wrapped bronze bushings	8
SKF PTFE composite bushings, thrust washers and strips . .	10
SKF POM composite bushings, thrust washers and strips . .	12
SKF PTFE polyamide bushings	14
SKF filament wound bushings	16

2 Product data

SKF bushings – product selection guide	18
SKF bushings – technical data	20
Bushing selection – overview of technical data	21
Product tables	24

A wide assortment to meet your needs

SKF – number one in bearings

SKF has gained a reputation for excellence in the roller bearing industry by providing customers with the highest quality products, solutions and services. Commitment to total quality is reflected in every product that SKF offers and bushings are no exception.

SKF – your bushing partner

With a global sales network and logistics expertise far superior to that of any competitor, SKF is able to provide customers with delivery services and product solutions that are second to none. Featuring the world's widest bushing stock assortment, SKF gives distributors and customers the ability to meet all of their industrial application needs with one single source.

Select the right bushing for the application

Throughout the world we are recognized as the leading rolling bearing manufacturer. We are renowned for our excellent technical support and application know-how. However, we are also a major player in the plain bearing field: spherical plain bearings, rod ends, and a much expanded range of bushings. The product selection guide in this catalogue simplifies the selection of bushings from our expanded range.

SKF solid bronze bushings
The traditional and robust bushing material



SKF sintered bronze bushings
Oil impregnation enables very high sliding velocity



SKF wrapped bronze bushings
Excellent in dirty environments due to lubrication pockets



SKF PTFE composite plain bearings
Long, maintenance-free service life due to low friction



SKF POM composite plain bearings
Optimized for minimal maintenance in difficult environments



SKF PTFE polyamide bushings
The cost-effective, maintenance-free bushing



SKF filament wound bushings
The maintenance-free bushing for extreme operating conditions



SKF solid bronze bushings



The traditional and robust bushing material

Solid bronze bushings, which are suitable for use in a wide variety of applications, are the most commonly used type of cylindrical bushing. The solid bronze material is well suited for highly demanding applications in tough environments. SKF offers a standard assortment of both straight and flanged bushings.



Advantages of SKF solid bronze bushings include:

- insensitive to dirty environments
- resistant to shock loads and vibrations at low speeds
- the possibility to operate with lower quality shaft finish
- good resistance to corrosive contaminants
- equipped with grooves to retain lubricant

Material

SKF solid bronze bushings are made of a multi-component bronze, CuSn7Zn4Pb7-B, which has very good sliding properties. All surfaces of a solid bronze bushing are machined.

Main applications¹⁾

SKF solid bronze bushings are intended for oscillating movements in both the radial and axial directions. SKF solid bronze bushings are also suitable for applications where rotating speeds are low.

Applications include:

- construction machinery
- transport equipment
- pulp and papermaking machinery
- offshore equipment

Positioning of the lubrication groove at different operating conditions

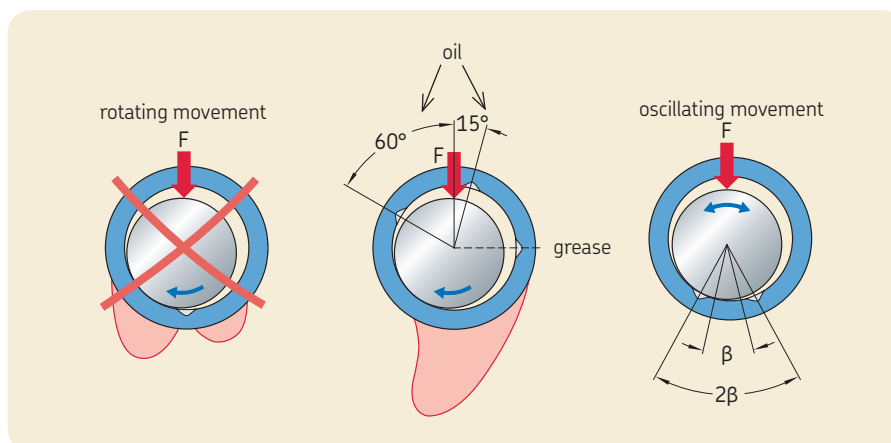

¹⁾ The performance of SKF solid bronze bushings depends on the interaction of load, lubrication, surface roughness, sliding velocity, and temperature encountered in specific applications.

Lubrication

SKF solid bronze bushings can be lubricated with either oil or grease. The lubricant not only improves the sliding properties, but also reduces wear and prevents corrosion. While oil is used in exceptional cases, solid bronze bushings are typically grease lubricated.

To protect the bushing and lubricant, seals are recommended in highly contaminated environments.

All bushings with a bore diameter > 14 mm incorporate an axial lubrication groove.

Characteristics

Permissible load (dyn/stat), N/mm ²	25 / 45
Permissible sliding velocity, m/s	0,5
Friction coefficient μ (greased)	0,08 .. 0,15
Temperature range, °C	-40 .. +250

Application recommendations

Shaft tolerance	e7 – e8
Housing tolerance	H7
Shaft roughness R_a , μm	0 .. 1,0
Shaft hardness, HB	165 – 400



SKF solid bronze bushings are available both as straight and flanged bushings.

SKF sintered bronze bushings



Oil impregnation enables very high sliding velocity

SKF sintered bronze cylindrical bushings are self-lubricating and maintenance-free. These bushings consist of a porous bronze matrix impregnated with lubricant. The permissible sliding velocity for sintered bronze bushings is very high, making them suitable for rotating applications. SKF offers a full line of both straight and flanged sintered bronze bushings.



Advantages of SKF sintered bronze bushings include:

- very high sliding velocity
- lubrication free
- maintenance-free operation
- good frictional properties

Material

SKF sintered bronze bushings consist of a sintered metallic bronze and graphite matrix (1% weight of graphite) with fully impregnated porosity. The material composition of SKF sintered bronze bushings is SINT A51 with a porosity volume of 28%, impregnated with mineral oil. Machining or grinding of the sliding surface of a porous sintered bushing is not recommended due to the risk of closing the bushing pores.

Main applications¹⁾

SKF sintered bronze bushings are most suitable for applications with rotating movements and where self-lubricating properties of the material are a prerequisite.

Applications include:

- electrical equipment
- household equipment
- printing machinery
- machine tools

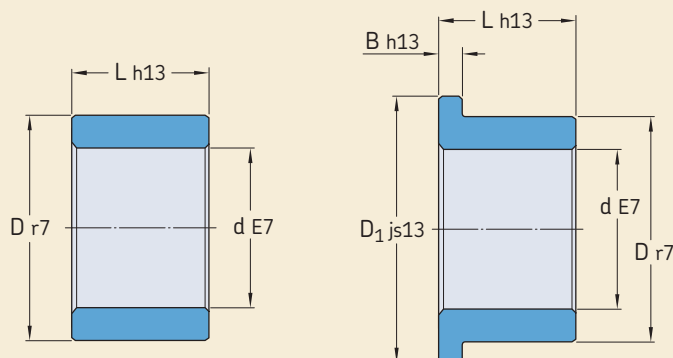

¹⁾ The performance of SKF sintered bronze bushings depends on the interaction of load, lubrication, surface roughness, sliding velocity, and temperature encountered in specific applications.

Lubrication

When storing or mounting, the bushing should never come in contact with absorbent material as it may wick the oil away very quickly. Therefore, SKF recommends keeping the bushing in its original package until just prior to mounting.

Additional lubrication is usually not necessary.

Characteristics

Permissible load (dyn/stat), N/mm ²	10 / 20
Permissible sliding velocity, m/s	0,25 .. 5
Friction coefficient μ (greased)	0,05 .. 0,10
Temperature range, °C	-10 .. +90

Application recommendations

Shaft tolerance	f7 – f8
Housing tolerance	H7
Shaft roughness R_a , μm	0,2 .. 0,8
Shaft hardness, HB	200 – 300



SKF sintered bronze bushings, which are impregnated with a lubricant, are available both as straight and flanged bushings.

SKF wrapped bronze bushings



Lubrication pockets help extend bushing service life

SKF wrapped bronze bushings are particularly well suited for applications where high levels of contamination make relubrication necessary. The sliding surface of an SKF wrapped bronze bushing contains diamond shaped pockets that must initially be filled with grease. The pockets act as reservoirs to progressively release lubricant during operation. SKF offers a full range of both straight and flanged wrapped bronze bushings. Straight bushings are manufactured to dimensions in accordance with ISO 3547-1.



Advantages of SKF wrapped bronze bushings include:

- insensitive to contaminated environments
- resistant to shock loads and vibrations at slow speeds
- good resistance to corrosive environments

Material

SKF wrapped bronze bushings are made entirely of bronze, CuSn8. The bushings are produced from strips which are then wrapped and calibrated.

Main applications¹⁾

These bushings are well suited for machinery that must operate in highly contaminated environments and where shock loads and/or vibrations occur.

Applications include:

- agricultural machinery
- hoisting equipment
- construction machinery
- forestry machinery

Diamond-shaped lubricant reservoirs



¹⁾ The performance of SKF wrapped bronze bushings depends on the interaction of load, lubrication, surface roughness, sliding velocity, and temperature encountered in specific applications.

Lubrication

Whether grease or oil is used, a good quality lubricant will reduce friction and wear by separating a bronze bushing from its shaft. To protect the bushing and lubricant in highly contaminated environments, SKF recommends using seals.

Characteristics

Permissible load (dyn/stat), N/mm ²	40 / 120
Permissible sliding velocity, m/s	1,0
Friction coefficient μ (greased)	0,08 .. 0,15
Temperature range, °C	-40 .. +150

Application recommendations

Shaft tolerance	e7 – f8
Housing tolerance	H7
Shaft roughness R_a , μm	0,4 .. 0,8
Shaft hardness, HB	150 – 400



SKF wrapped bronze bushings are available both as straight and flanged bushings.

SKF PTFE composite bushings, thrust washers and strips



Extend service life with PTFE composite plain bearings

SKF PTFE composite plain bearings are the maintenance-free solution to premature bearing failure in heavy load/medium speed applications. The SKF assortment of PTFE composite plain bearings consist of a wide range of both straight and flanged bushings, thrust washers and strips.

Straight bushings are manufactured to dimensions in accordance with ISO 3547-1.

Advantages of SKF PTFE composite plain bearings include:

- maintenance-free operation
- very good frictional properties
- high load carrying capacity
- operating temperatures up to 250 °C
- sliding velocity up to 2 m/s
- small operating clearance



Material

SKF PTFE composite plain bearings combine the mechanical strength of steel with the low friction of a PTFE-based self-lubricating lead-free sliding layer. The intermediate layer of porous tin bronze creates a strong bond between the backing and sliding surfaces and also improves the dissipation of heat generated during operation. To protect the bearings from corrosion, the steel backing is tin-plated. With the exception of the sliding surface, PTFE composite dry sliding bearings can be machined. Calibration is possible within certain limits.

Main applications¹⁾

SKF PTFE composite dry sliding bearings are suitable for applications where there are heavy loads and where a sliding material with self-lubricating properties is a prerequisite.

Applications include:

- automotive
- material handling equipment
- home appliances and consumer goods
- textile machinery

Cross section of SKF PTFE composite plain bearings

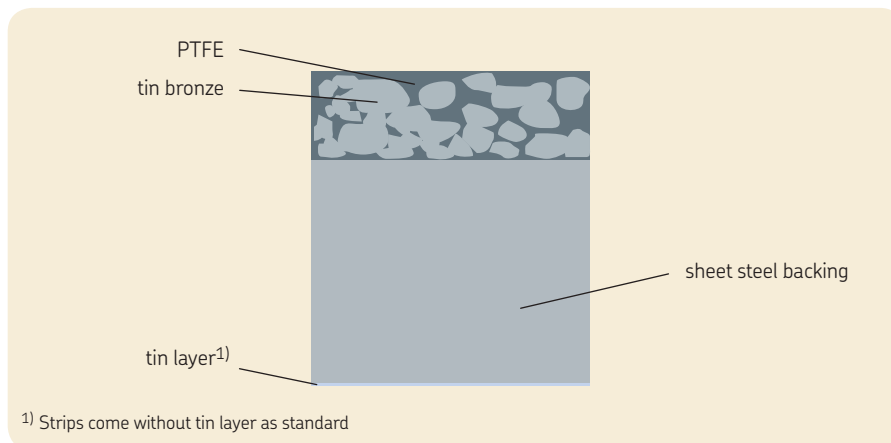

¹⁾ Strips come without tin layer as standard

¹⁾ The performance of SKF PTFE composite plain bearings depends on the interaction of load, lubrication, surface roughness, sliding velocity, and temperature encountered in specific applications.

Lubrication

The PTFE-based sliding surface permits smooth, low-friction operation without lubrication. During a short running-in phase, there will be some transfer of PTFE material from the sliding contact surface to the counterface. After this transfer, the characteristic low friction and wear properties of these bearings will be achieved.

The presence, or continuous supply of oil or other non-corrosive fluids may be advantageous and improve the performance of these bearings.

Characteristics

Permissible load (dyn/stat), N/mm ²	80 ($v \leq 0,02$) / 250
Permissible sliding velocity, m/s	2,0 ($p \leq 1,0$) ¹⁾
Friction coefficient μ	0,03 .. 0,25
Temperature range, °C	-200 .. +250

Application recommendations

Shaft tolerance	f7 – h8
Housing tolerance	H7
Shaft roughness R_a , μm	0 .. 0,4
Shaft hardness, HB	300 – 600

¹⁾ See page 20



SKF PTFE composite plain bearings are available, both as straight and flanged bushings, washers and strips.

SKF POM composite bushings, thrust washers and strips



Optimal combination of minimal maintenance under tough operating conditions

SKF POM composite plain bearings are referred to as prelubricated because they require only a trace of lubricant to operate satisfactorily for long periods. The bearing material is designed to operate with marginal lubrication and effectively fills the gap between fully lubricated bearings and dry sliding bearings. The SKF assortment of POM composite plain bearings consist of a wide range of straight bushings, thrust washers and strips.

Straight bushings are manufactured to dimensions in accordance with ISO 3547-1.

Advantages of SKF POM composite plain bearings include:

- maintenance-free operation
- very good frictional properties
- high load carrying capacity
- high sliding velocity
- small operating clearance

Material

SKF POM composite plain bearings are suitable for applications that require minimal maintenance under difficult operating conditions. As a result of the lubricant retention pockets on the sliding surface, SKF POM composite plain bearings are especially well-suited for applications in contaminated environments where lubricant cannot be supplied continuously or frequently.

Main applications¹⁾

SKF POM composite plain bearings are suitable for applications where there are heavy loads and where the self-lubricating properties of the material are a prerequisite.

Applications include:

- agricultural equipment
- construction machinery
- material handling equipment
- home appliances and consumer goods



Cross section of SKF POM composite plain bearings

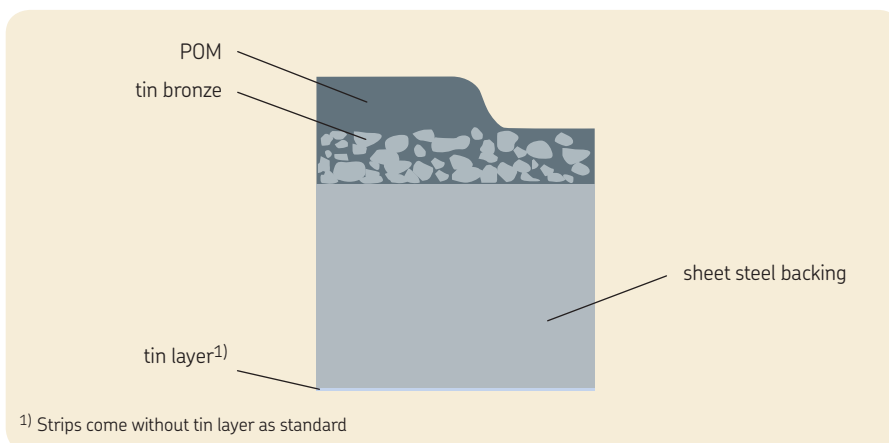

¹⁾ The performance of SKF POM composite plain bearings depends on the interaction of load, lubrication, surface roughness, sliding velocity, and temperature encountered in specific applications.

Lubrication

SKF POM composite plain bearings are designed to operate under marginal lubrication conditions. The sliding surface of these plain bearings contains grease reservoirs which should be filled prior to installation. It is not necessary to relubricate these plain bearings, but the presence of a lubricant can extend the plain bearing service life considerably. To protect the mating surface against corrosion, grease can be applied periodically.

Characteristics

Permissible load (dyn/stat), N/mm ²	120 ($v \leq 0,02$) / 250
Permissible sliding velocity, m/s	2,5 ($p \leq 1,0$) ¹⁾
Friction coefficient μ	0,02 .. 0,20
Temperature range, °C	-40 .. +110

Application recommendations

Shaft tolerance	f7 – h8
Housing tolerance	H7
Shaft roughness R_a , μm	0 .. 0,8
Shaft hardness, HB	150 – 600

¹⁾ See page 20



SKF POM composite plain bearings are available as straight bushings, washers and strips.

SKF PTFE polyamide bushings



The cost-effective maintenance-free bushing

The thermoplastic material used to make SKF PTFE polyamide bushings provides maintenance-free, dry sliding operation. SKF PTFE polyamide bushings are designed for applications where other polymer bushings might fail prematurely. These thin-walled bushings promote heat dissipation, enabling high sliding velocities. SKF offers a standard assortment of both straight and flanged PTFE polyamide bushings. Straight bushings are manufactured to dimensions in accordance with ISO 3547-1.

Advantages of SKF PTFE polyamide bushings include:

- maintenance-free
- cost-effective
- corrosion-resistant
- electrical insulator



Material

SKF PTFE polyamide bushings are made from a glass-fibre reinforced thermoplastic that contains PTFE. The material mix enables these self-lubricating, wear-resistant bushings to accommodate moderate loads.

Main applications¹⁾

SKF PTFE polyamide bushings are suitable for applications where cost-effective maintenance-free bushings are preferred.

Applications include:

- textile machinery
- medical equipment
- fitness equipment
- household equipment

¹⁾ The performance of SKF PTFE polyamide bushings depends on the interaction of load, lubrication, surface roughness, sliding velocity, and temperature encountered in specific applications.

Lubrication

SKF PTFE polyamide bushings are designed for dry operation. A lubricant can, however, improve the performance of these bushings. With an adequate supply of grease, oil, water or other liquid, the operating speed of these bushings can be increased. SKF PTFE polyamide bushings are resistant to most lubricating oils and greases.

Characteristics

Permissible load (dyn/stat), N/mm ²	40 / 80
Permissible sliding velocity, m/s	1,0
Friction coefficient μ	0,06 .. 0,15
Temperature range, °C	-30 .. +110

Application recommendations

Shaft tolerance	h8 – h9
Housing tolerance	H7
Shaft roughness R_a , μm	0 .. 0,8
Shaft hardness, HB	100 – 300



SKF PTFE polyamide bushings are available both as straight and flanged bushings.

SKF filament wound bushings



The maintenance-free bushing for extreme operating conditions

SKF filament wound bushings are made from resin and fibres wound in multiple layers. This composite material was specially developed to accommodate heavy loads, vibrations and corrosive environments.

SKF filament wound bushings are often dimensionally interchangeable with solid bronze or steel bushings. SKF offers a standard assortment of filament wound bushings with dimensions in accordance with ISO 4379.

Advantages of SKF filament wound bushings include:

- high load carrying capacity
- accommodate shock loads and vibrations
- low sensitivity to misalignment and edge loading
- maintenance-free operation
- corrosion-resistant
- very good frictional behaviour
- very good electrical insulator

Material

The modern technique of fibre winding, together with a specially developed resin matrix, combines the outstanding mechanical properties of glass-fibre with the excellent tribological behaviour of PTFE and high strength thermoplastic PES fibres. With the exception of the sliding layer, all SKF filament wound bushings can be machined.

Main applications¹⁾

SKF filament wound bushings are suitable for applications where there are heavy loads and vibrations and where maintenance-free operation is preferred.

Applications include:

- construction machinery
- agricultural and forestry machinery
- hoisting and conveyor equipment
- offshore equipment



Cross section of SKF filament wound bushing

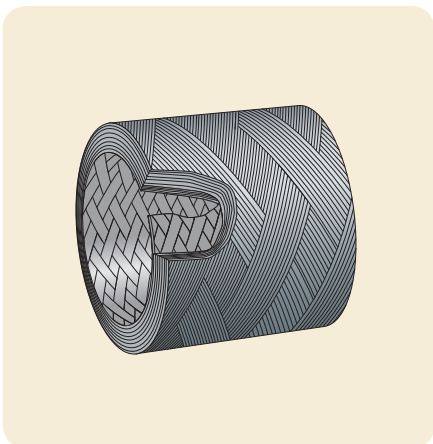

¹⁾ The performance of SKF filament wound bushings depends on the interaction of load, lubrication, surface roughness, sliding velocity, and temperature encountered in specific applications .

Lubrication

SKF filament wound bushings have excellent dry sliding characteristics due to the unique sliding surface consisting of PTFE and PES fibres in an epoxy resin. The low friction sliding surface does not require additional lubricant. However, the presence of a lubricant offers protection against contaminants and has no negative effect.

NOTE: Seals are recommended when the bushing is to be used in a highly contaminated environment.

Characteristics

Permissible load (dyn/stat), N/mm ²	140 / 200
Permissible sliding velocity, m/s	0,5
Friction coefficient μ	0,03 .. 0,08
Temperature range, °C	-50 .. +140



Application recommendations

Shaft tolerance	h8
Housing tolerance	H7
Shaft roughness R_a , μm	0,2 – 0,4
Shaft hardness, HB	> 490

SKF filament wound bushings are available as straight bushings.

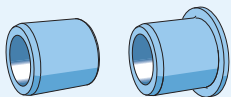
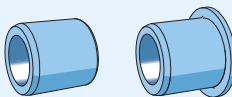

SKF bushings, thrust washers and strips

	 Solid bronze	 Sintered bronze
Self-lubricating performance	not suitable	good
Maintenance-free operation	not suitable	good
Dirty environments	good	suitable
Corrosion-resistant	good	suitable
High temperature	good	not suitable
Heavy load	suitable	not suitable
Shock loads/vibrations	good	suitable
High sliding velocity	not suitable	excellent
Low friction	not suitable	good
Poor shaft surface finish	good	not suitable
Small operating clearance	not suitable	suitable
Insensitive to misalignment	good	suitable
Assortment		
Product series designation	PBM PBMF	PSM PSMF

– product selection guide

 <p>Wrapped bronze</p>	 <p>PTFE composite</p>	 <p>POM composite</p>	 <p>PTFE polyamide</p>	 <p>Filament wound</p>
not suitable	excellent	good	excellent	excellent
suitable	excellent	good	excellent	excellent
excellent	not suitable	suitable	not suitable	good
good	suitable	suitable	excellent	excellent
good	excellent	suitable	suitable	good
suitable	good	excellent	suitable	good
good	suitable	suitable	not suitable	excellent
suitable	good	good	suitable	not suitable
not suitable	excellent	excellent	suitable	excellent
suitable	not suitable	suitable	suitable	suitable
suitable	excellent	good	suitable	not suitable
suitable	not suitable	suitable	suitable	good
				
PRM PRMF	PCM .. E PCMF .. E PCMW .. E PCMS .. E	PCM .. M PCMW .. M PCMS .. M	PPM PPMF	PWM

SKF bushings – technical data

	 Solid bronze	 Sintered bronze	 Wrapped bronze	 PTFE composite	 POM composite	 PTFE polyamide	 Filament wound
Temperature range, °C	-40 .. +250	-10 .. +90	-40 .. +150	-200 .. +250	-40 .. +110	-30 .. +110	-50 .. +140
Friction coefficient, μ	0,08 .. 0,15	0,05 .. 0,10	0,08 .. 0,15	0,03 .. 0,25	0,02 .. 0,20	0,06 .. 0,15	0,03 .. 0,08
Permissible load, N/mm ²							
– dynamic	25	10	40	80 ($v \leq 0,02$)	120 ($v \leq 0,02$)	40	140
– static	45	20	120	250	250	80	200
Permissible sliding velocity, m/s	0,5	0,25 .. 5	1,0	2,0 ($p \leq 1,0$)	2,5 ($p \leq 1,0$)	1,0	0,5
Shaft tolerance	e7 – e8	f7 – f8	e7 – f8	f7 – h8	h7 – h8	h8 – h9	h8
Housing tolerance	H7	H7	H7	H7	H7	H7	H7
Shaft roughness R_a , μm	0 .. 1,0	0,2 .. 0,8	0,4 .. 0,8	0 .. 0,4	0 .. 0,8	0 .. 0,8	0,2 – 0,4
Shaft hardness, HB	165 – 400	200 – 300	150 – 400	300 – 600	150 – 600	100 – 300	> 490
Assortment and product series designation	 PBM  PBMF	 PSM  PSMF	 PRM  PRMF	 PCM .. E  PCMF .. E  PCMW .. E  PCMS .. E	 PCM .. M  PCMW .. M  PCMS .. M	 PPM  PPMF	 PWM

The sliding velocity can be calculated using

$$v = n \times \pi \times d / (60 \times 1\,000)$$

where

v = sliding velocity, m/s

n = rotational speed, r/min

d = bore diameter of bushing, mm

The specific bearing load can be calculated using

$$p = F / (d \times b)$$

where

p = specific bearing load, N/mm²

F = bearing load, N

d = bore diameter of bushing, mm

b = width of bushing, mm

Bushing selection

Overview of technical data

The temperature range for SKF solid and wrapped bronze bushings can be extended by using special lubricants.

Temperature range

Ambient temperature range (°C) for different SKF sliding materials under normal operating conditions.

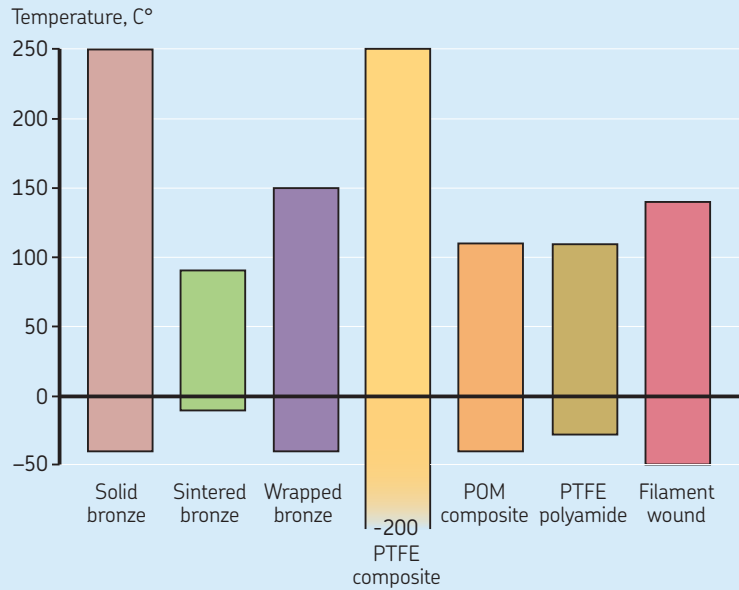

The primary factors that affect the friction of SKF sliding materials against their mating surfaces include load, sliding velocity, surface roughness of the mating surface and lubrication conditions.

Lower coefficients of friction are obtained under heavy specific loads at low sliding velocities (not applicable to SKF sintered bronze).

Both higher and lower friction can occur under extreme conditions.

Coefficient of friction

Coefficient of friction (μ) under dry or initially lubricated operating conditions (typical values) for different SKF sliding materials.

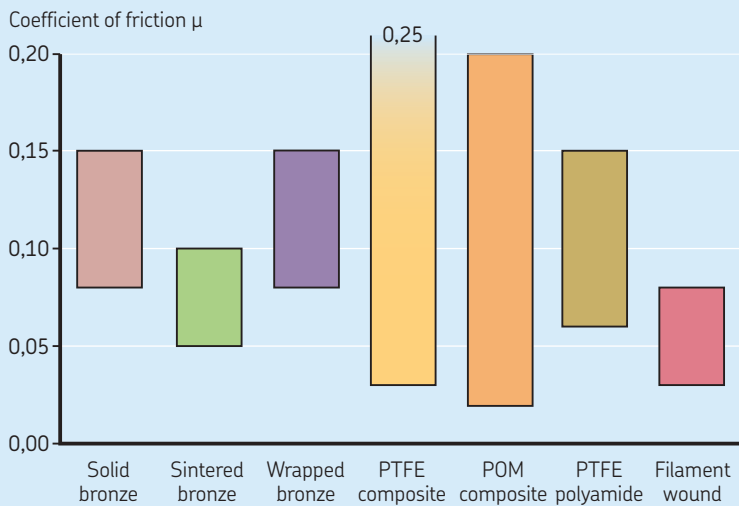

The load carrying capacity of a specific bushing depends on several factors including the type of load, sliding velocity and frequency of oscillation.

All sliding materials supplied by SKF can operate under rotational, oscillating and linear movements. The permissible sliding velocity for a specific application also depends on load, shaft surface and heat dissipation.

Load capacity

Permissible specific bearing load, p (dynamic), N/mm^2 , at a sliding velocity less than 0,01 m/s and permissible static load (N/mm^2) at $v = 0$ m/s for different SKF sliding materials.

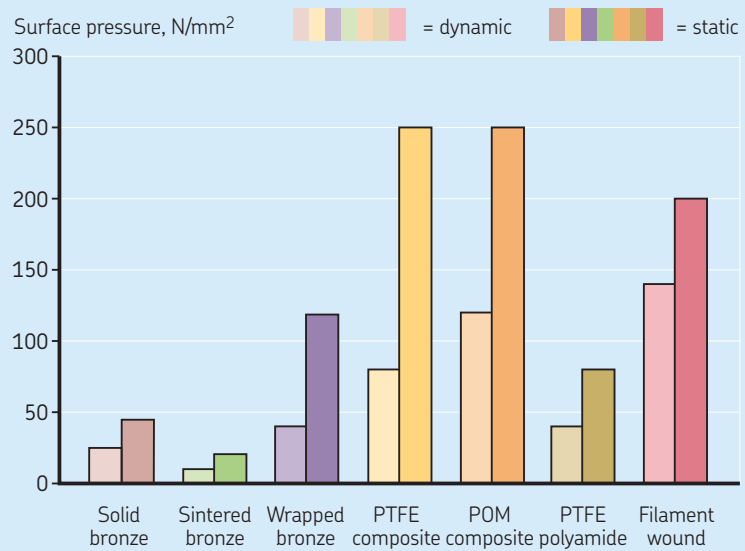

Sliding velocity

Permissible continuous sliding velocity (m/s) at a load less than 1 N/mm^2 under dry or initially lubricated operating conditions for different SKF sliding materials.

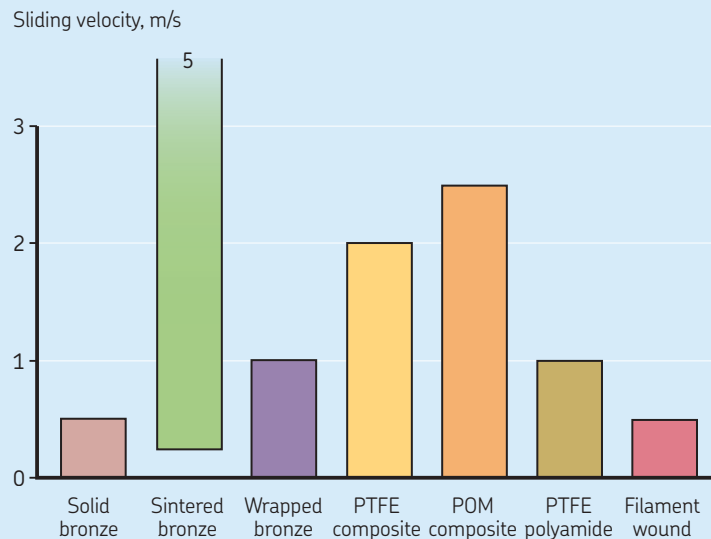

Larger tolerance grades can be used when the application demands are moderate.

The surface roughness often has a significant influence on service life. However, a surface roughness with a value greater than 0,4 μm may have a negative effect.

The heavier the load, the harder the shaft should be. The higher the risk for embedded contaminants, the more a harder shaft is required.

Shaft recommendations

Recommended ISO tolerances, surface roughness and surface hardness of the shaft for different SKF sliding materials.

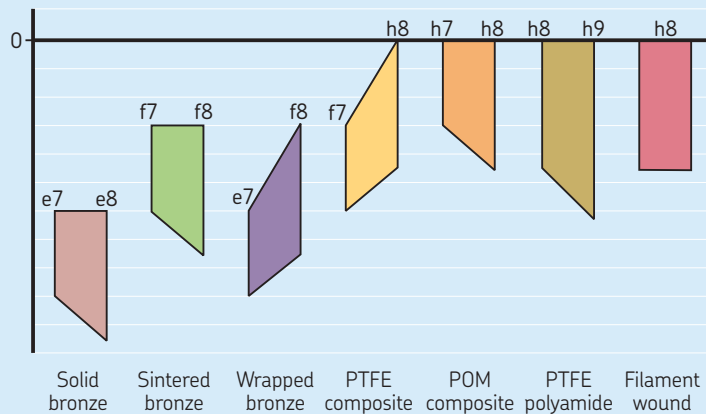

Shaft surface roughness R_a , μm

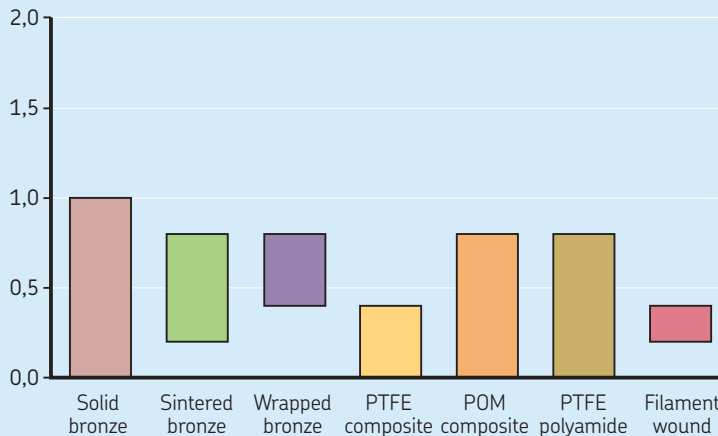

Shaft surface hardness, HB

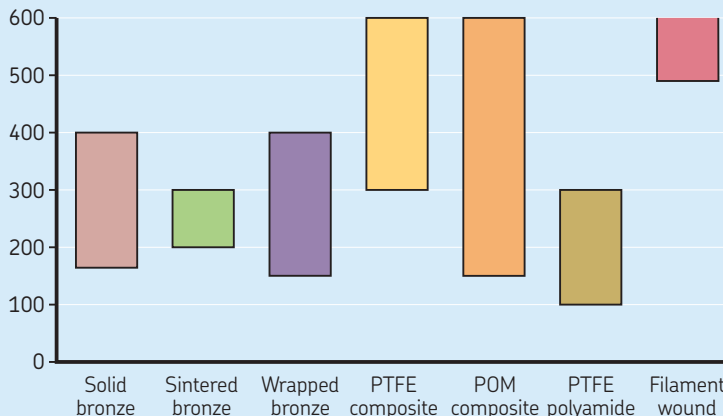

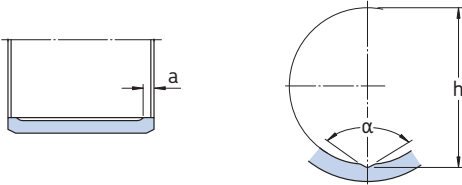

d mm	a mm	h mm	α °
12-22	3	d+1	105
25-55	3	d+1	124
60-130	B×0,05	d+1,5	124
140-190	B×0,05	d+2,0	124
>190	B×0,05	d+2,5	124

Designation ¹⁾	d	D	B
	mm	mm	mm
PBM 809570 M1G1	80	95	70
PBM 8095100 M1G1	80	95	100
PBM 8095140 M1G1	80	95	140
PBM 8510070 M1G1	85	100	70
PBM 85100100 M1G1	85	100	100
PBM 85100140 M1G1	85	100	140
PBM 9011080 M1G1	90	110	80
PBM 90110120 M1G1	90	110	120
PBM 90110160 M1G1	90	110	160
PBM 9511580 M1G1	95	115	80
PBM 95115120 M1G1	95	115	120
PBM 95115160 M1G1	95	115	160
PBM 10012080 M1G1	100	120	80
PBM 100120120 M1G1	100	120	120
PBM 100120160 M1G1	100	120	160
PBM 10512580 M1G1	105	125	80
PBM 105125120 M1G1	105	125	120
PBM 105125160 M1G1	105	125	160
PBM 11013080 M1G1	110	130	80
PBM 110130140 M1G1	110	130	140
PBM 110130200 M1G1	110	130	200
PBM 12014080 M1G1	120	140	80
PBM 120140140 M1G1	120	140	140
PBM 120140200 M1G1	120	140	200
PBM 13015090 M1G1	130	150	90
PBM 130150140 M1G1	130	150	140
PBM 130150200 M1G1	130	150	200
PBM 14016090 M1G1	140	160	90
PBM 140160160 M1G1	140	160	160
PBM 140160200 M1G1	140	160	200
PBM 150170100 M1G1	150	170	100
PBM 150170160 M1G1	150	170	160
PBM 150170240 M1G1	150	170	240
PBM 160180100 M1G1	160	180	100
PBM 160180160 M1G1	160	180	160
PBM 160180240 M1G1	160	180	240
PBM 170190100 M1G1	170	190	100
PBM 170190160 M1G1	170	190	160
PBM 170190240 M1G1	170	190	240

Designation ¹⁾	d	D	B
	mm	mm	mm
PBM 180200100 M1G1	180	200	100
PBM 180200160 M1G1	180	200	160
PBM 180200240 M1G1	180	200	240
PBM 190210120 M1G1	190	210	120
PBM 190210200 M1G1	190	210	200
PBM 190210300 M1G1	190	210	300
PBM 200220120 M1G1	200	220	120
PBM 200220200 M1G1	200	220	200
PBM 200220300 M1G1	200	220	300
PBM 210230120 M1G1	210	230	120
PBM 210230200 M1G1	210	230	200
PBM 210230300 M1G1	210	230	300
PBM 220240140 M1G1	220	240	140
PBM 220240250 M1G1	220	240	250
PBM 220240350 M1G1	220	240	350
PBM 230250140 M1G1	230	250	140
PBM 230250250 M1G1	230	250	250
PBM 230250350 M1G1	230	250	350
PBM 240260140 M1G1	240	260	140
PBM 240260250 M1G1	240	260	250
PBM 240260350 M1G1	240	260	350
PBM 250270140 M1G1	250	270	140
PBM 250270250 M1G1	250	270	250
PBM 250270350 M1G1	250	270	350

¹⁾ M1 = bronze material CuSn7Zn4Pb7-B (see page 4), G1 = lubrication groove
Other dimensions available on request

SKF solid bronze – flanged bushings
d 5 – 250 mm

Designation system

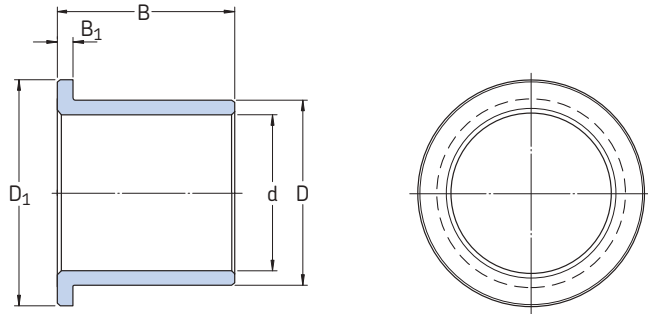
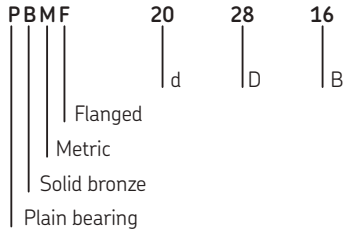

Designation ¹⁾	d	D	B	D ₁	B ₁	Designation ¹⁾	d	D	B	D ₁	B ₁
	mm	mm	mm	mm	mm		mm	mm	mm	mm	mm
PBMF 051006 M1	5	10	6	12	2	PBMF 405025 M1G1	40	50	25	60	6
PBMF 061206 M1	6	12	6	14	2	PBMF 405040 M1G1	40	50	40	60	6
PBMF 071208 M1	7	12	8	16	3	PBMF 455530 M1G1	45	55	30	65	6
PBMF 081408 M1	8	14	8	18	3	PBMF 455545 M1G1	45	55	45	65	6
PBMF 091408 M1	9	14	8	18	3	PBMF 506030 M1G1	50	60	30	70	6
PBMF 091410 M1	9	14	10	18	3	PBMF 506050 M1G1	50	60	50	70	6
PBMF 101608 M1	10	16	8	20	3	PBMF 557030 M1G1	55	70	30	80	8
PBMF 101610 M1	10	16	10	20	3	PBMF 557050 M1G1	55	70	50	80	8
PBMF 121810 M1	12	18	10	22	3	PBMF 607535 M1G1	60	75	35	85	8
PBMF 121812 M1	12	18	12	22	3	PBMF 607560 M1G1	60	75	60	85	8
PBMF 142010 M1G1	14	20	10	25	3	PBMF 658035 M1G1	65	80	35	90	8
PBMF 142012 M1G1	14	20	12	25	3	PBMF 658060 M1G1	65	80	60	90	8
PBMF 152212 M1G1	15	22	12	28	3	PBMF 708535 M1G1	70	85	35	95	8
PBMF 152216 M1G1	15	22	16	28	3	PBMF 708560 M1G1	70	85	60	95	8
PBMF 162212 M1G1	16	22	12	28	4	PBMF 759040 M1G1	75	90	40	100	8
PBMF 162216 M1G1	16	22	16	28	4	PBMF 759070 M1G1	75	90	70	100	8
PBMF 172512 M1G1	17	25	12	32	4	PBMF 809540 M1G1	80	95	40	105	8
PBMF 172516 M1G1	17	25	16	32	4	PBMF 809570 M1G1	80	95	70	105	8
PBMF 182512 M1G1	18	25	12	32	4	PBMF 8510040 M1G1	85	100	40	110	8
PBMF 182516 M1G1	18	25	16	32	4	PBMF 8510070 M1G1	85	100	70	110	8
PBMF 202816 M1G1	20	28	16	35	4	PBMF 9011050 M1G1	90	110	50	120	8
PBMF 202820 M1G1	20	28	20	35	4	PBMF 9011080 M1G1	90	110	80	120	8
PBMF 223216 M1G1	22	32	16	40	5	PBMF 9511550 M1G1	95	115	50	125	8
PBMF 223220 M1G1	22	32	20	40	5	PBMF 9511580 M1G1	95	115	80	125	8
PBMF 253516 M1G1	25	35	16	45	5	PBMF 10012050 M1G1	100	120	50	130	8
PBMF 253525 M1G1	25	35	25	45	5	PBMF 10012080 M1G1	100	120	80	130	8
PBMF 284016 M1G1	28	40	16	50	5	PBMF 10512550 M1G1	105	125	50	135	8
PBMF 284025 M1G1	28	40	25	50	5	PBMF 10512580 M1G1	105	125	80	135	8
PBMF 304020 M1G1	30	40	20	50	5	PBMF 11013050 M1G1	110	130	50	140	8
PBMF 304030 M1G1	30	40	30	50	5	PBMF 11013080 M1G1	110	130	80	140	8
PBMF 354520 M1G1	35	45	20	55	5	PBMF 12014050 M1G1	120	140	50	150	8
PBMF 354535 M1G1	35	45	35	55	5	PBMF 12014080 M1G1	120	140	80	150	8

¹⁾ M1 = bronze material CuSn7Zn4Pb7-B (see page 4), G1 = lubrication groove
Other dimensions available on request

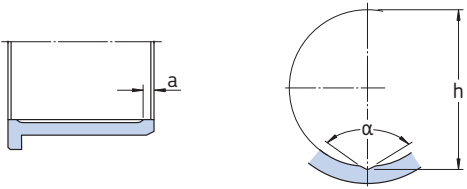

d mm	a mm	h mm	α °
12-22	3	d+1	105
25-55	3	d+1	124
60-130	B×0,05	d+1,5	124
140-190	B×0,05	d+2,0	124
>190	B×0,05	d+2,5	124

Designation ¹⁾	d	D	B	D ₁	B ₁
	mm	mm	mm	mm	mm
PBMF 13015060 M1G1	130	150	60	165	10
PBMF 13015090 M1G1	130	150	90	165	10
PBMF 14016060 M1G1	140	160	60	175	10
PBMF 14016090 M1G1	140	160	90	175	10
PBMF 15017070 M1G1	150	170	70	185	10
PBMF 150170100 M1G1	150	170	100	185	10
PBMF 16018070 M1G1	160	180	70	195	10
PBMF 160180100 M1G1	160	180	100	195	10
PBMF 17019070 M1G1	170	190	70	205	10
PBMF 170190100 M1G1	170	190	100	205	10
PBMF 18020070 M1G1	180	200	70	215	10
PBMF 180200100 M1G1	180	200	100	215	10
PBMF 19021080 M1G1	190	210	80	225	10
PBMF 190210120 M1G1	190	210	120	225	10
PBMF 20022080 M1G1	200	220	80	235	10
PBMF 200220120 M1G1	200	220	120	235	10
PBMF 21023080 M1G1	210	230	80	245	10
PBMF 210230120 M1G1	210	230	120	245	10
PBMF 220240100 M1G1	220	240	100	255	10
PBMF 220240140 M1G1	220	240	140	255	10
PBMF 230250100 M1G1	230	250	100	265	10
PBMF 230250140 M1G1	230	250	140	265	10
PBMF 240260100 M1G1	240	260	100	275	10
PBMF 240260140 M1G1	240	260	140	275	10
PBMF 250270100 M1G1	250	270	100	285	10
PBMF 250270140 M1G1	250	270	140	285	10

¹⁾ M1 = bronze material CuSn7Zn4Pb7-B (see page 4), G1 = lubrication groove
Other dimensions available on request

SKF sintered bronze – straight bushings

d 2 – 60 mm

Designation system

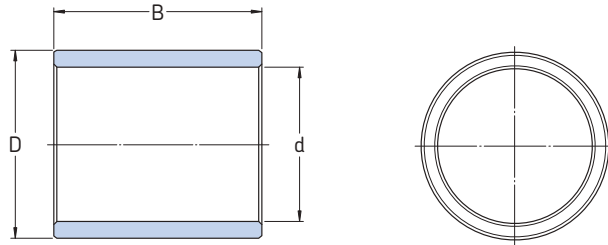
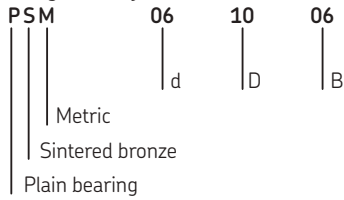

Designation ¹⁾	d	D	B	Designation ¹⁾	d	D	B
	mm	mm	mm		mm	mm	mm
PSM 020404 A51	2	4	4	PSM 121816 A51	12	18	16
PSM 030804 A51	3	8	4	PSM 121820 A51	12	18	20
PSM 040708 A51	4	7	8	PSM 121825 A51	12	18	25
PSM 040804 A51	4	8	4	PSM 122525 A51	12	25	25
PSM 040806 A51	4	8	6	PSM 141810 A51	14	18	10
PSM 041008 A51	4	10	8	PSM 141814 A51	14	18	14
PSM 051006 A51	5	10	6	PSM 141820 A51	14	18	20
PSM 051008 A51	5	10	8	PSM 142010 A51	14	20	10
PSM 051010 A51	5	10	10	PSM 142012 A51	14	20	12
PSM 051210 A51	5	12	10	PSM 142014 A51	14	20	14
PSM 060904 A51	6	9	4	PSM 142020 A51	14	20	20
PSM 060906 A51	6	9	6	PSM 142030 A51	14	20	30
PSM 060910 A51	6	9	10	PSM 142830 A51	14	28	30
PSM 061004 A51	6	10	4	PSM 151910 A51	15	19	10
PSM 061006 A51	6	10	6	PSM 151915 A51	15	19	15
PSM 061010 A51	6	10	10	PSM 151925 A51	15	19	25
PSM 061206 A51	6	12	6	PSM 152010 A51	15	20	10
PSM 061208 A51	6	12	8	PSM 152015 A51	15	20	15
PSM 061212 A51	6	12	12	PSM 152020 A51	15	20	20
PSM 061412 A51	6	14	12	PSM 152025 A51	15	20	25
PSM 081106 A51	8	11	6	PSM 152030 A51	15	20	30
PSM 081108 A51	8	11	8	PSM 152110 A51	15	21	10
PSM 081112 A51	8	11	12	PSM 152115 A51	15	21	15
PSM 081206 A51	8	12	6	PSM 152125 A51	15	21	25
PSM 081208 A51	8	12	8	PSM 152216 A51	15	22	16
PSM 081212 A51	8	12	12	PSM 152220 A51	15	22	20
PSM 081408 A51	8	14	8	PSM 152230 A51	15	22	30
PSM 081412 A51	8	14	12	PSM 153030 A51	15	30	30
PSM 081416 A51	8	14	16	PSM 162012 A51	16	20	12
PSM 081816 A51	8	18	16	PSM 162016 A51	16	20	16
PSM 101408 A51	10	14	8	PSM 162025 A51	16	20	25
PSM 101410 A51	10	14	10	PSM 162212 A51	16	22	12
PSM 101416 A51	10	14	16	PSM 162216 A51	16	22	16
PSM 101608 A51	10	16	8	PSM 162220 A51	16	22	20
PSM 101610 A51	10	16	10	PSM 162225 A51	16	22	25
PSM 101616 A51	10	16	16	PSM 163230 A51	16	32	30
PSM 101620 A51	10	16	20	PSM 182212 A51	18	22	12
PSM 102220 A51	10	22	20	PSM 182218 A51	18	22	18
PSM 121608 A51	12	16	8	PSM 182230 A51	18	22	30
PSM 121612 A51	12	16	12	PSM 182412 A51	18	24	12
PSM 121620 A51	12	16	20	PSM 182418 A51	18	24	18
PSM 121808 A51	12	18	8	PSM 182430 A51	18	24	30
PSM 121812 A51	12	18	12	PSM 182516 A51	18	25	16
				PSM 182520 A51	18	25	20
				PSM 182530 A51	18	25	30
				PSM 183530 A51	18	35	30

¹⁾ A51 = see page 6, section about material
Other dimensions available on request

Designation ¹⁾	d	D	B	Designation ¹⁾	d	D	B
	mm	mm	mm		mm	mm	mm
PSM 202515 A51	20	25	15	PSM 354125 A51	35	41	25
PSM 202520 A51	20	25	20	PSM 354135 A51	35	41	35
PSM 202525 A51	20	25	25	PSM 354140 A51	35	41	40
PSM 202530 A51	20	25	30	PSM 354525 A51	35	45	25
PSM 202615 A51	20	26	15	PSM 354535 A51	35	45	35
PSM 202620 A51	20	26	20	PSM 354540 A51	35	45	40
PSM 202625 A51	20	26	25	PSM 354550 A51	35	45	50
PSM 202630 A51	20	26	30	PSM 354570 A51	35	45	70
PSM 202820 A51	20	28	20				
PSM 202830 A51	20	28	30	PSM 404630 A51	40	46	30
PSM 202840 A51	20	28	40	PSM 404640 A51	40	46	40
PSM 204040 A51	20	40	40	PSM 404650 A51	40	46	50
				PSM 405030 A51	40	50	30
PSM 222715 A51	22	27	15	PSM 405040 A51	40	50	40
PSM 222720 A51	22	27	20	PSM 405050 A51	40	50	50
PSM 222725 A51	22	27	25	PSM 405060 A51	40	50	60
PSM 223220 A51	22	32	20				
PSM 223230 A51	22	32	30	PSM 455135 A51	45	51	35
				PSM 455145 A51	45	51	45
PSM 253020 A51	25	30	20	PSM 455155 A51	45	51	55
PSM 253025 A51	25	30	25	PSM 455535 A51	45	55	35
PSM 253030 A51	25	30	30	PSM 455545 A51	45	55	45
PSM 253220 A51	25	32	20	PSM 455555 A51	45	55	55
PSM 253225 A51	25	32	25	PSM 455560 A51	45	55	60
PSM 253230 A51	25	32	30	PSM 455565 A51	45	55	65
PSM 253232 A51	25	32	32				
PSM 253235 A51	25	32	35	PSM 506035 A51	50	60	35
PSM 253525 A51	25	35	25	PSM 506050 A51	50	60	50
PSM 253535 A51	25	35	35	PSM 506070 A51	50	60	70
PSM 253550 A51	25	35	50	PSM 507070 A51	50	70	70
PSM 254535 A51	25	45	35				
				PSM 556540 A51	55	65	40
PSM 303520 A51	30	35	20	PSM 556555 A51	55	65	55
PSM 303525 A51	30	35	25	PSM 556570 A51	55	65	70
PSM 303530 A51	30	35	30	PSM 557070 A51	55	70	70
PSM 303820 A51	30	38	20				
PSM 303825 A51	30	38	25	PSM 606850 A51	60	68	50
PSM 303830 A51	30	38	30	PSM 606860 A51	60	68	60
PSM 303840 A51	30	38	40	PSM 606870 A51	60	68	70
PSM 304030 A51	30	40	30	PSM 607050 A51	60	70	50
PSM 304045 A51	30	40	45	PSM 607060 A51	60	70	60
PSM 304060 A51	30	40	60	PSM 607250 A51	60	72	50
PSM 305060 A51	30	50	60	PSM 607260 A51	60	72	60
				PSM 607270 A51	60	72	70
				PSM 607560 A51	60	75	60
				PSM 607590 A51	60	75	90

¹⁾ A51 = see page 6, section about material
Other dimensions available on request

SKF sintered bronze – straight bushings
d 65 – 100 mm

Designation system

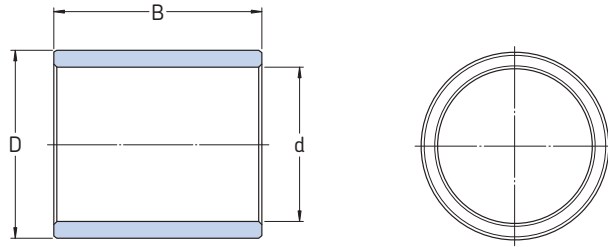
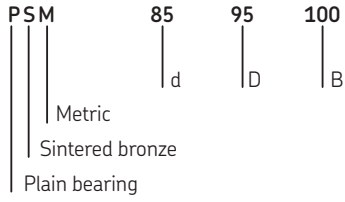

Designation ¹⁾	d	D	B
	mm	mm	mm
PSM 657560 A51	65	75	60
PSM 658060 A51	65	80	60
PSM 708060 A51	70	80	60
PSM 708560 A51	70	85	60
PSM 708590 A51	70	85	90
PSM 758570 A51	75	85	70
PSM 7585100 A51	75	85	100
PSM 759070 A51	75	90	70
PSM 7590100 A51	75	90	100
PSM 75100100 A51	75	100	100
PSM 809070 A51	80	90	70
PSM 809570 A51	80	95	70
PSM 8095100 A51	80	95	100
PSM 80105100 A51	80	105	100
PSM 8595100 A51	85	95	100
PSM 85100100 A51	85	100	100
PSM 9010580 A51	90	105	80
PSM 9011080 A51	90	110	80
PSM 10012080 A51	100	120	80

¹⁾ A51 = see page 6, section about material
 Other dimensions available on request

SKF sintered bronze – flanged bushings
d 3 – 100 mm

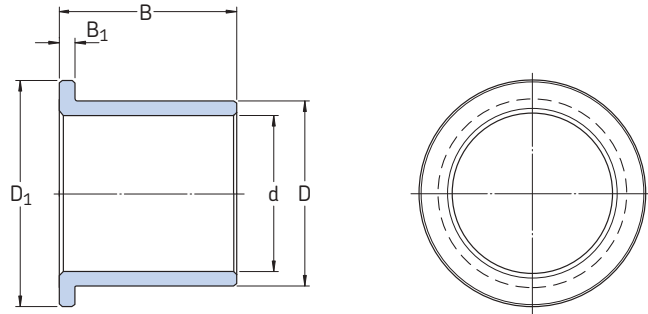
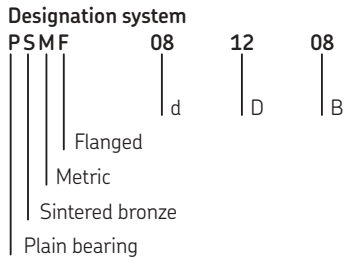

Designation ¹⁾	d	D	B	D ₁	B ₁
	mm	mm	mm	mm	mm
PSMF 030504 A51	3	5	4	8	1,5
PSMF 030604 A51	3	6	4	9	1,5
PSMF 040804 A51	4	8	4	12	2
PSMF 040806 A51	4	8	6	12	2
PSMF 050904 A51	5	9	4	13	2
PSMF 050905 A51	5	9	5	13	2
PSMF 050908 A51	5	9	8	13	2
PSMF 051006 A51	5	10	6	14	2
PSMF 061004 A51	6	10	4	14	2
PSMF 061006 A51	6	10	6	14	2
PSMF 061010 A51	6	10	10	14	2
PSMF 061206 A51	6	12	6	14	2
PSMF 081206 A51	8	12	6	16	2
PSMF 081208 A51	8	12	8	16	2
PSMF 081212 A51	8	12	12	16	2
PSMF 081408 A51	8	14	8	18	3
PSMF 101608 A51	10	16	8	22	3
PSMF 101610 A51	10	16	10	22	3
PSMF 101616 A51	10	16	16	22	3
PSMF 121808 A51	12	18	08	24	3
PSMF 121810 A51	12	18	10	24	3
PSMF 121812 A51	12	18	12	24	3
PSMF 121820 A51	12	18	20	24	3
PSMF 142010 A51	14	20	10	26	3
PSMF 142012 A51	14	20	12	26	3
PSMF 142014 A51	14	20	14	26	3
PSMF 142020 A51	14	20	20	26	3
PSMF 152015 A51	15	20	15	27	3
PSMF 152025 A51	15	20	25	27	3
PSMF 152110 A51	15	21	10	27	3
PSMF 152115 A51	15	21	15	27	3
PSMF 152125 A51	15	21	25	27	3
PSMF 152212 A51	15	22	12	28	3
PSMF 152216 A51	15	22	16	28	3
PSMF 162212 A51	16	22	12	28	3
PSMF 162216 A51	16	22	16	28	3
PSMF 162225 A51	16	22	25	28	3
PSMF 182412 A51	18	24	12	30	3
PSMF 182418 A51	18	24	18	30	3
PSMF 182430 A51	18	24	30	30	3
PSMF 182512 A51	18	25	12	32	4
PSMF 182516 A51	18	25	16	32	4

Designation ¹⁾	d	D	B	D ₁	B ₁
	mm	mm	mm	mm	mm
PSMF 202615 A51	20	26	15	32	3
PSMF 202620 A51	20	26	20	32	3
PSMF 202625 A51	20	26	25	32	3
PSMF 202630 A51	20	26	30	32	3
PSMF 202816 A51	20	28	16	35	4
PSMF 202820 A51	20	28	20	35	4
PSMF 253220 A51	25	32	20	39	3,5
PSMF 253225 A51	25	32	25	39	3,5
PSMF 253230 A51	25	32	30	39	3,5
PSMF 253516 A51	25	35	16	45	5
PSMF 253525 A51	25	35	25	45	5
PSMF 303830 A51	30	38	30	46	4
PSMF 304020 A51	30	40	20	50	5
PSMF 304030 A51	30	40	30	50	5
PSMF 354520 A51	35	45	20	55	5
PSMF 354525 A51	35	45	25	55	5
PSMF 354535 A51	35	45	35	55	5
PSMF 354540 A51	35	45	40	55	5
PSMF 405030 A51	40	50	30	60	5
PSMF 405040 A51	40	50	40	60	5
PSMF 405050 A51	40	50	50	60	5
PSMF 455530 A51	45	55	30	65	5
PSMF 455535 A51	45	55	35	65	5
PSMF 455545 A51	45	55	45	65	5
PSMF 455555 A51	45	55	55	65	5
PSMF 506030 A51	50	60	30	70	5
PSMF 506035 A51	50	60	35	70	5
PSMF 506050 A51	50	60	50	70	5
PSMF 607250 A51	60	72	50	84	6
PSMF 607260 A51	60	72	60	84	6
PSMF 607535 A51	60	75	35	85	8
PSMF 607560 A51	60	75	60	85	8
PSMF 708560 A51	70	85	60	95	8
PSMF 809570 A51	80	95	70	105	8
PSMF 9011050 A51	90	110	50	120	8
PSMF 10012080 A51	100	120	80	130	8

¹⁾ A51 = see page 6, section about material
Other dimensions available on request

SKF wrapped bronze – straight bushings
d 12 – 100 mm

Designation system

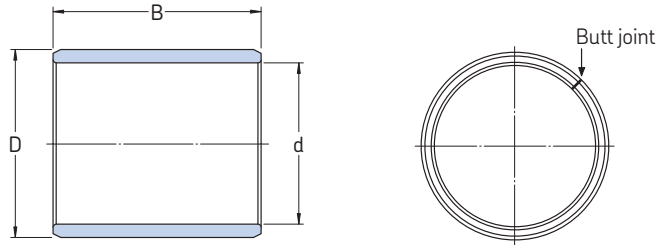
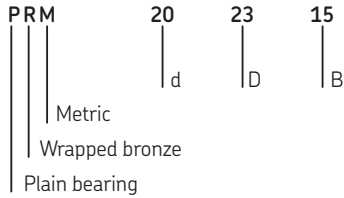

Designation	d	D	B	Designation	d	D	B
	mm	mm	mm		mm	mm	mm
PRM 121415	12	14	15	PRM 606530	60	65	30
PRM 151715	15	17	15	PRM 606540	60	65	40
PRM 151725	15	17	25	PRM 606550	60	65	50
PRM 161815	16	18	15	PRM 606560	60	65	60
PRM 161820	16	18	20	PRM 657040	65	70	40
PRM 161825	16	18	25	PRM 657060	65	70	60
PRM 182115	18	21	15	PRM 707540	70	75	40
PRM 182120	18	21	20	PRM 707560	70	75	60
PRM 182125	18	21	25	PRM 707580	70	75	80
PRM 202315	20	23	15	PRM 758080	75	80	80
PRM 202320	20	23	20	PRM 808540	80	85	40
PRM 202325	20	23	25	PRM 808560	80	85	60
PRM 202330	20	23	30	PRM 808580	80	85	80
PRM 252815	25	28	15	PRM 859080	85	90	80
PRM 252820	25	28	20	PRM 909550	90	95	50
PRM 252825	25	28	25	PRM 909590	90	95	90
PRM 252830	25	28	30	PRM 10010550	100	105	50
PRM 303420	30	34	20	PRM 10010595	100	105	95
PRM 303430	30	34	30				
PRM 303440	30	34	40				
PRM 323620	32	36	20				
PRM 323630	32	36	30				
PRM 353920	35	39	20				
PRM 353930	35	39	30				
PRM 353940	35	39	40				
PRM 353950	35	39	50				
PRM 404420	40	44	20				
PRM 404430	40	44	30				
PRM 404440	40	44	40				
PRM 404450	40	44	50				
PRM 455030	45	50	30				
PRM 455040	45	50	40				
PRM 455050	45	50	50				
PRM 455060	45	50	60				
PRM 505530	50	55	30				
PRM 505540	50	55	40				
PRM 505550	50	55	50				
PRM 505560	50	55	60				
PRM 556040	55	60	40				
PRM 556060	55	60	60				

Other dimensions available on request

SKF wrapped bronze – flanged bushings
d 20 – 100 mm

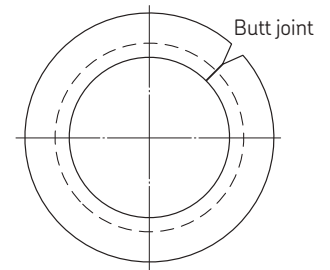
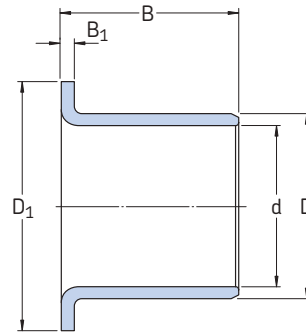
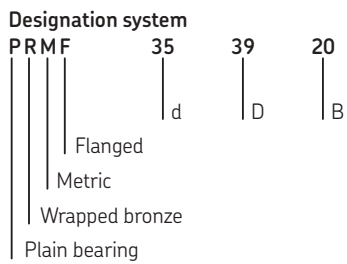

Designation	d	D	B	D ₁	B ₁
	mm	mm	mm	mm	mm
PRMF 202316	20	23	16	30	1,5
PRMF 202320	20	23	20	30	1,5
PRMF 252815	25	28	15	35	1,5
PRMF 252825	25	28	25	35	1,5
PRMF 303420	30	34	20	45	2
PRMF 303430	30	34	30	45	2
PRMF 353920	35	39	20	50	2
PRMF 353935	35	39	35	50	2
PRMF 404425	40	44	25	55	2
PRMF 404440	40	44	40	55	2
PRMF 455030	45	50	30	60	2,5
PRMF 455045	45	50	45	60	2,5
PRMF 505530	50	55	30	65	2,5
PRMF 505550	50	55	50	65	2,5
PRMF 556050	55	60	50	70	2,5
PRMF 606530	60	65	30	75	2,5
PRMF 606560	60	65	60	75	2,5
PRMF 657060	65	70	60	80	2,5
PRMF 707540	70	75	40	85	2,5
PRMF 707570	70	75	70	85	2,5
PRMF 758070	75	80	70	90	2,5
PRMF 808540	80	85	40	100	2,5
PRMF 808580	80	85	80	100	2,5
PRMF 909550	90	95	50	110	2,5
PRMF 10010550	100	105	50	120	2,5

Other dimensions available on request

SKF PTFE composite – straight bushings

d 3 – 200 mm

Designation system

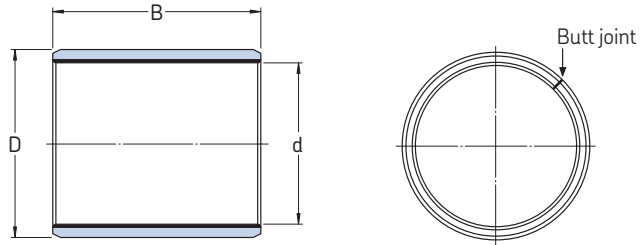
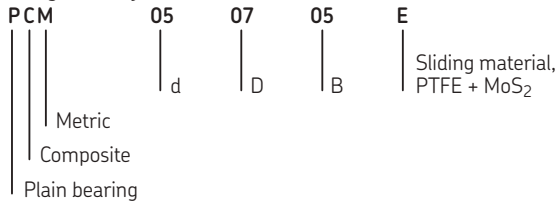

Designation ¹⁾	d	D	B	Designation	d	D	B
	mm	mm	mm		mm	mm	mm
PCM 030403 E/VB055	3	4,5	3	PCM 161810 E	16	18	10
PCM 030405 E/VB055	3	4,5	5	PCM 161812 E	16	18	12
PCM 030406 E/VB 055	3	4,5	6	PCM 161815 E	16	18	15
PCM 040503 E/VB055	4	5,5	3	PCM 161820 E	16	18	20
PCM 040504 E/VB055	4	5,5	4	PCM 161825 E	16	18	25
PCM 040506 E/VB055	4	5,5	6	PCM 171920 E	17	19	20
PCM 040510 E/VB055	4	5,5	10	PCM 182015 E	18	20	15
PCM 050705 E	5	7	5	PCM 182020 E	18	20	20
PCM 050708 E	5	7	8	PCM 182025 E	18	20	25
PCM 050710 E	5	7	10	PCM 202210 E	20	22	10
PCM 060806 E	6	8	6	PCM 202220 E	20	22	20
PCM 060808 E	6	8	8	PCM 202310 E	20	23	10
PCM 060810 E	6	8	10	PCM 202315 E	20	23	15
PCM 081006 E	8	10	6	PCM 202320 E	20	23	20
PCM 081008 E	8	10	8	PCM 202325 E	20	23	25
PCM 081010 E	8	10	10	PCM 202330 E	20	23	30
PCM 081012 E	8	10	12	PCM 222515 E	22	25	15
PCM 101208 E	10	12	8	PCM 222520 E	22	25	20
PCM 101210 E	10	12	10	PCM 222525 E	22	25	25
PCM 101212 E	10	12	12	PCM 222530 E	22	25	30
PCM 101215 E	10	12	15	PCM 242715 E	24	27	15
PCM 101220 E	10	12	20	PCM 242720 E	24	27	20
PCM 121408 E	12	14	8	PCM 242730 E	24	27	30
PCM 121410 E	12	14	10	PCM 252810 E	25	28	10
PCM 121412 E	12	14	12	PCM 252812 E	25	28	12
PCM 121415 E	12	14	15	PCM 252815 E	25	28	15
PCM 121420 E	12	14	20	PCM 252820 E	25	28	20
PCM 121425 E	12	14	25	PCM 252825 E	25	28	25
PCM 141610 E	14	16	10	PCM 252830 E	25	28	30
PCM 141612 E	14	16	12	PCM 252840 E	25	28	40
PCM 141615 E	14	16	15	PCM 252850 E	25	28	50
PCM 141620 E	14	16	20	PCM 283220 E	28	32	20
PCM 141625 E	14	16	25	PCM 283225 E	28	32	25
PCM 151710 E	15	17	10	PCM 283230 E	28	32	30
PCM 151712 E	15	17	12	PCM 303415 E	30	34	15
PCM 151715 E	15	17	15	PCM 303420 E	30	34	20
PCM 151720 E	15	17	20	PCM 303425 E	30	34	25
PCM 151725 E	15	17	25	PCM 303430 E	30	34	30
				PCM 303440 E	30	34	40

¹⁾ VB055 means outer diameter D does not correspond to D in the designation, but is 0,5mm larger
Other dimensions available on request

Designation	d	D	B	Designation	d	D	B
	mm	mm	mm		mm	mm	mm
PCM 323620 E	32	36	20	PCM 859030 E	85	90	30
PCM 323630 E	32	36	30	PCM 859060 E	85	90	60
PCM 323640 E	32	36	40	PCM 909560 E	90	95	60
PCM 353920 E	35	39	20	PCM 9095100 E	90	95	100
PCM 353930 E	35	39	30	PCM 9510060 E	95	100	60
PCM 353940 E	35	39	40	PCM 95100100 E	95	100	100
PCM 353950 E	35	39	50	PCM 10010560 E	100	105	60
PCM 374020 E	37	40	20	PCM 100105115 E	100	105	115
PCM 404420 E	40	44	20	PCM 11011560 E	110	115	60
PCM 404430 E	40	44	30	PCM 110115115 E	110	115	115
PCM 404440 E	40	44	40	PCM 12012560 E	120	125	60
PCM 404450 E	40	44	50	PCM 120125100 E	120	125	100
PCM 455020 E	45	50	20	PCM 130135100 E	130	135	100
PCM 455030 E	45	50	30	PCM 14014560 E	140	145	60
PCM 455040 E	45	50	40	PCM 140145100 E	140	145	100
PCM 455050 E	45	50	50	PCM 15015560 E	150	155	60
PCM 505520 E	50	55	20	PCM 15015580 E	150	155	80
PCM 505530 E	50	55	30	PCM 150155100 E	150	155	100
PCM 505540 E	50	55	40	PCM 160165100 E	160	165	100
PCM 505560 E	50	55	60	PCM 180185100 E	180	185	100
PCM 556030 E	55	60	30	PCM 200205100 E	200	205	100
PCM 556040 E	55	60	40				
PCM 556060 E	55	60	60				
PCM 606520 E	60	65	20				
PCM 606530 E	60	65	30				
PCM 606540 E	60	65	40				
PCM 606560 E	60	65	60				
PCM 606570 E	60	65	70				
PCM 657030 E	65	70	30				
PCM 657050 E	65	70	50				
PCM 657070 E	65	70	70				
PCM 707540 E	70	75	40				
PCM 707550 E	70	75	50				
PCM 707570 E	70	75	70				
PCM 758060 E	75	80	60				
PCM 758080 E	75	80	80				
PCM 808540 E	80	85	40				
PCM 808560 E	80	85	60				
PCM 8085100 E	80	85	100				

Other dimensions available on request

SKF PTFE composite – flanged bushings

d 6 – 35 mm

Designation system

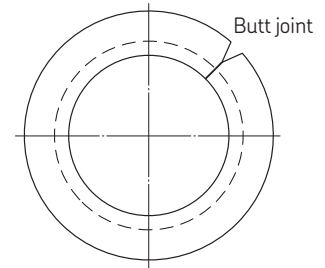
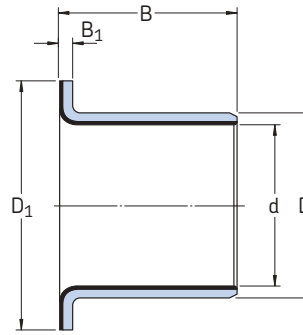
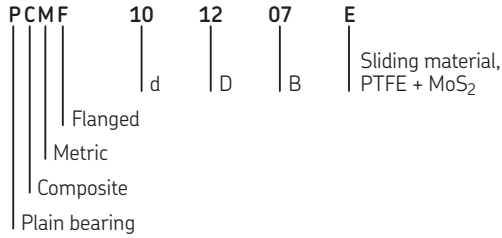

Designation	d	D	B	D ₁	B ₁
	mm	mm	mm	mm	mm
PCMF 060804 E	6	8	4	12	1
PCMF 060808 E	6	8	8	12	1
PCMF 081005.5 E	8	10	5,5	15	1
PCMF 081007.5 E	8	10	7,5	15	1
PCMF 081009.5 E	8	10	9,5	15	1
PCMF 101207 E	10	12	7	18	1
PCMF 101209 E	10	12	9	18	1
PCMF 101212 E	10	12	12	18	1
PCMF 101217 E	10	12	17	18	1
PCMF 121407 E	12	14	7	20	1
PCMF 121409 E	12	14	9	20	1
PCMF 121412 E	12	14	12	20	1
PCMF 121415 E	12	14	15	20	1
PCMF 121417 E	12	14	17	20	1
PCMF 141612 E	14	16	12	22	1
PCMF 141617 E	14	16	17	22	1
PCMF 151709 E	15	17	9	23	1
PCMF 151712 E	15	17	12	23	1
PCMF 151717 E	15	17	17	23	1
PCMF 161812 E	16	18	12	24	1
PCMF 161817 E	16	18	17	24	1
PCMF 182012 E	18	20	12	26	1
PCMF 182017 E	18	20	17	26	1
PCMF 182022 E	18	20	22	26	1
PCMF 202311.5 E	20	23	11,5	30	1,5
PCMF 202315 E	20	23	15	30	1,5
PCMF 202316.5 E	20	23	16,5	30	1,5
PCMF 202321.5 E	20	23	21,5	30	1,5
PCMF 252811.5 E	25	28	11,5	35	1,5
PCMF 252816.5 E	25	28	16,5	35	1,5
PCMF 252821.5 E	25	28	21,5	35	1,5
PCMF 303416 E	30	34	16	42	2
PCMF 303426 E	30	34	26	42	2
PCMF 353916 E	35	39	16	47	2
PCMF 353926 E	35	39	26	47	2

Other dimensions available on request

SKF PTFE composite – strips
 B 100 – 200 mm

Designation system
 PCMS 100 500 1.50 E
 | | | |
 | Strip
 | Metric
 | Composite
 | Plain bearing
 | Sliding material,
 | PTFE + MoS₂

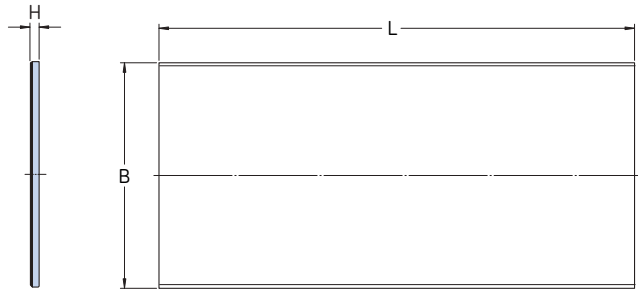

Designation	B	L	H
	mm	mm	mm
PCMS 1005001.0 E	100	500	1
PCMS 1005001.50 E	100	500	1,5
PCMS 1005002.0 E	100	500	2
PCMS 1005002.50 E	100	500	2,5
PCMS 1005003.06 E	100	500	3,06
PCMS 2005001.0 E	200	500	1
PCMS 2005001.50 E	200	500	1,5
PCMS 2005002.0 E	200	500	2
PCMS 2005002.50 E	200	500	2,5
PCMS 2005003.06 E	200	500	3,06

Other dimensions available on request

SKF POM composite – straight bushings
d 8 – 150 mm

Designation system

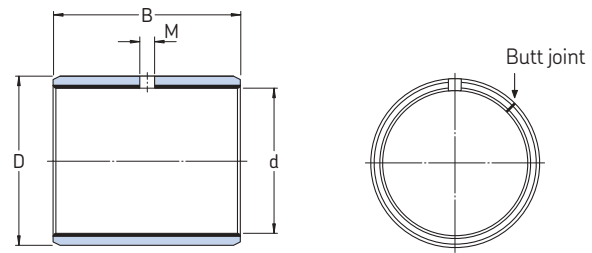
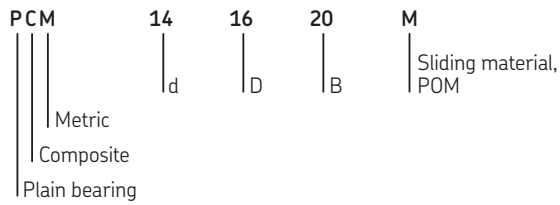

Designation	d	D	B	M
	mm	mm	mm	mm
PCM 081008 M	8	10	8	–
PCM 081010 M	8	10	10	–
PCM 081012 M	8	10	12	–
PCM 101210 M	10	12	10	–
PCM 101212 M	10	12	12	3
PCM 101215 M	10	12	15	3
PCM 101220 M	10	12	20	3
PCM 121410 M	12	14	10	3
PCM 121415 M	12	14	15	3
PCM 121420 M	12	14	20	3
PCM 141620 M	14	16	20	3
PCM 141625 M	14	16	25	3
PCM 151715 M	15	17	15	3
PCM 161815 M	16	18	15	3
PCM 161820 M	16	18	20	3
PCM 161825 M	16	18	25	3
PCM 182015 M	18	20	15	3
PCM 182020 M	18	20	20	3
PCM 182025 M	18	20	25	3
PCM 202310 M	20	23	10	3
PCM 202315 M	20	23	15	3
PCM 202320 M	20	23	20	3
PCM 202325 M	20	23	25	3
PCM 202330 M	20	23	30	3
PCM 222515 M	22	25	15	3
PCM 222520 M	22	25	20	3
PCM 222525 M	22	25	25	3
PCM 252815 M	25	28	15	4
PCM 252820 M	25	28	20	4
PCM 252825 M	25	28	25	4
PCM 252830 M	25	28	30	4
PCM 283220 M	28	32	20	4
PCM 283225 M	28	32	25	4
PCM 283230 M	28	32	30	4
PCM 303420 M	30	34	20	4
PCM 303430 M	30	34	30	4
PCM 303440 M	30	34	40	4
PCM 323630 M	32	36	30	4

Designation	d	D	B	M
	mm	mm	mm	mm
PCM 353920 M	35	39	20	4
PCM 353930 M	35	39	30	4
PCM 353950 M	35	39	50	4
PCM 404420 M	40	44	20	4
PCM 404430 M	40	44	30	4
PCM 404440 M	40	44	40	4
PCM 404450 M	40	44	50	4
PCM 455030 M	45	50	30	5
PCM 455040 M	45	50	40	5
PCM 455050 M	45	50	50	5
PCM 505530 M	50	55	30	5
PCM 505540 M	50	55	40	5
PCM 505560 M	50	55	60	5
PCM 556040 M	55	60	40	6
PCM 606530 M	60	65	30	6
PCM 606540 M	60	65	40	6
PCM 606560 M	60	65	60	6
PCM 606570 M	60	65	70	6
PCM 657050 M	65	70	50	6
PCM 657070 M	65	70	70	6
PCM 707540 M	70	75	40	6
PCM 707550 M	70	75	50	6
PCM 707570 M	70	75	70	6
PCM 758040 M	75	80	40	6
PCM 758060 M	75	80	60	6
PCM 808540 M	80	85	40	6
PCM 808560 M	80	85	60	6
PCM 808580 M	80	85	80	6
PCM 8085100 M	80	85	100	6
PCM 859060 M	85	90	60	6
PCM 909560 M	90	95	60	6
PCM 9095100 M	90	95	100	6
PCM 9510060 M	95	100	60	6
PCM 10010560 M	100	105	60	6
PCM 10010580 M	100	105	80	6
PCM 100105115 M	100	105	1	1

Other dimensions available on request

Designation	d	D	B	M
	mm	mm	mm	mm
PCM 11011560 M	110	115	60	8
PCM 110115115 M	110	115	115	8
PCM 12012560 M	120	125	60	8
PCM 120125100 M	120	125	100	8
PCM 130135100 M	130	135	100	8
PCM 14014560 M	140	145	60	8
PCM 15015560 M	150	155	60	8

Other dimensions available on request

SKF POM composite – thrust washers
d 14 – 52 mm

Designation system

PCMW	26	44	1.5	M
	d	D	H	Sliding material, POM
	Thrust washer			
	Metric			
	Composite			
	Plain bearing			

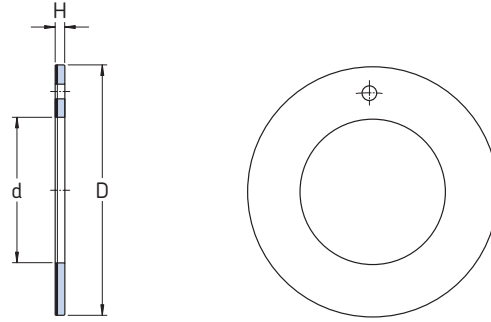

Designation	d	D	H
	mm	mm	mm
PCMW 142601.5 M	14	26	1,5
PCMW 203601.5 M	20	36	1,5
PCMW 264401.5 M	26	44	1,5
PCMW 325401.5 M	32	54	1,5
PCMW 426601.5 M	42	66	1,5
PCMW 527802 M	52	78	2

Other dimensions available on request

SKF PTFE polyamide – straight bushings
d 8 – 30 mm

Designation system

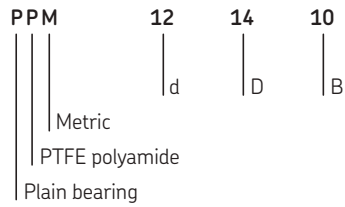

SKF PTFE polyamide – flanged bushings
d 10 – 25 mm

Designation system

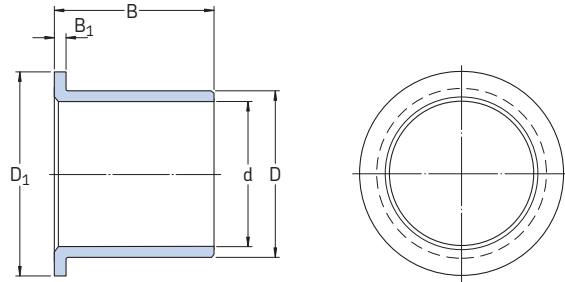
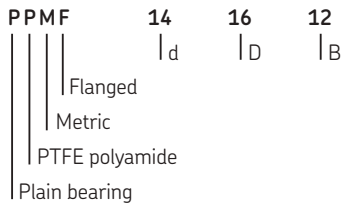

Designation	d	D	B	D ₁	B ₁
	mm	mm	mm	mm	mm
PPMF 101207	10	12	7	18	1
PPMF 101212	10	12	12	18	1
PPMF 121409	12	14	9	20	1
PPMF 121412	12	14	12	20	1
PPMF 141612	14	16	12	22	1
PPMF 141617	14	16	17	22	1
PPMF 151712	15	17	12	23	1
PPMF 151717	15	17	17	23	1
PPMF 161817	16	18	17	24	1
PPMF 202311.5	20	23	11,5	30	1,5
PPMF 202321.5	20	23	21,5	30	1,5
PPMF 252811.5	25	28	11,5	35	1,5
PPMF 252821.5	25	28	21,5	35	1,5

Other dimensions available on request

Designation	d	D	B
	mm	mm	mm
PWM 190210150	190	210	150
PWM 190210180	190	210	180
PWM 190210250	190	210	250
PWM 200220180	200	220	180
PWM 200220200	200	220	200
PWM 200220250	200	220	250

Other dimensions available on request

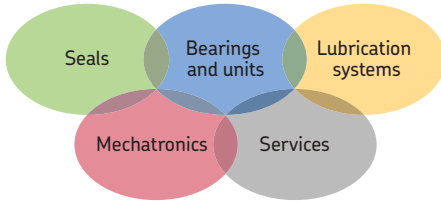

The Power of Knowledge Engineering

Drawing on five areas of competence and application-specific expertise amassed over more than 100 years, SKF brings innovative solutions to OEMs and production facilities in every major industry worldwide. These five competence areas include bearings and units, seals, lubrication systems, mechatronics (combining mechanics and electronics into intelligent systems), and a wide range of services, from 3-D computer modelling to advanced condition monitoring and reliability and asset management systems. A global presence provides SKF customers uniform quality standards and worldwide product availability.

© SKF is a registered trademark of the SKF Group

© SKF Group 2010

The contents of this publication are the copyright of the publisher and may not be reproduced (even extracts) unless prior written permission is granted. Every care has been taken to ensure the accuracy of the information contained in this publication but no liability can be accepted for any loss or damage whether direct, indirect or consequential arising out of the use of the information contained herein.

PUB BU/P2 06225/1 EN · March 2010

This publication supersedes publication PUB BU/P2 06225 EN

Printed in Sweden on environmentally friendly paper.

Certain images used under license from Shutterstock.com

